



**GEAR PUMPS**

Member of the Danfoss Group

**TUROLLA**   
*fast forward thinking*

**GEAR PUMPS**

**Group 4** | Technical Information





## History of revisions

Date	Page	Changed	Rev.
28, June 2010	-	First edition	A
30, Sept 2013	ALL	Layout and options lists	B

## Reference documents

Title	Type	Order number
General Aluminum Gear Pumps and Motors	Technical Information	L1016238
Group 1 Gear Pumps	Technical Information	L1016399
Group 2 Gear Pumps	Technical Information	L1016341
Group 3 Gear Pumps	Technical Information	L1016456
Group 1, 2 and 3 Gear Motors	Technical Information	L1016082
Hydraulic Fluids and Lubricants	Technical Information	L1021414

© 2013 Turolla™. All rights reserved.

Turolla accepts no responsibility for possible errors in catalogs, brochures and other printed material. Turolla reserves the right to alter its products without prior notice. This also applies to products already ordered provided that such alterations can be made without affecting agreed specifications. All trademarks in this material are properties of their respective owners. Danfoss, Turolla, Turolla OpenCircuitGear, OpenCircuitGear, Fast Lane and PLUS+1 are trademarks of the Danfoss Group.



# Index

## General Information

- 4 Overview
- 4 Group 4 gear pumps` attributes
- 4 Pump displacements
- 5 Pump design
- 6 Technical data for TAP4NN
- 7 Determination of nominal pump sizes

## Product Code

- 8 Model code

## System Requirements

- 12 Pressure
- 12 Speed
- 13 Hydraulic fluids
- 13 Temperature and viscosity
- 14 Filtration
- 14 Filters
- 14 Selecting a filter
- 15 Reservoir
- 15 Line sizing
- 16 Pump drive
- 17 Pump drive data form
- 18 Pump life

## Product Options

- 19 Shaft, flange, and port configurations
- 20 Mounting flanges
- 21 Shaft options
- 22 Port configurations
- 23 Porting

## Dimensions

- 24 TAP4NN – 01FA, 01DA and 01BA
- 25 TAP4NN – 02RA and 02GA



## General information

### Overview

The Turolla Group 4 is a range of peak performance fixed-displacement gear pumps. Constructed of a high-strength extruded aluminum body with aluminum cover and flange, all pumps are pressure-balanced for exceptional efficiency.

#### TAP4NN 01BA

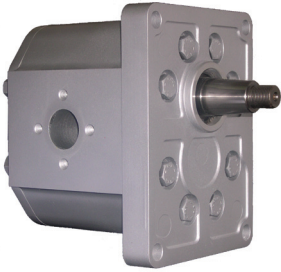

### Group 4 gear pumps` attributes

- Wide range of displacements from 60 to 200 cm<sup>3</sup>/rev [from 3.66 to 12.2 in<sup>3</sup>/rev]
- Continuous pressure rating up to 220 bar [3191 psi]
- Speeds up to 3000 min<sup>-1</sup> (rpm)
- SAE and European standard mounting flanges
- High quality case hardened steel gears
- Multiple pump configurations in combination with SNP1NN, SNP2NN and SNP3NN

### Pump displacements

Quick reference chart for *pump* displacements vs. rated pressure

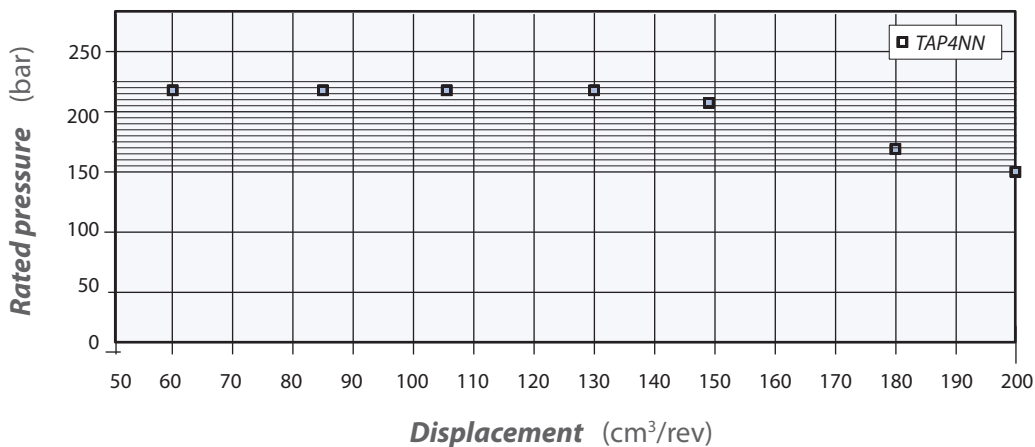



## Pump design

### TAP4NN

The TAP4NN gear pump is available in a displacement range from 60.0 to 200.0 cm<sup>3</sup>/rev [from 3.66 to 12.2 in<sup>3</sup>/rev]. Suitable for applications where the pressure is lower than 220 bar[3191 psi] continuous, the TAP4NN range is released into SAE and European configurations.

### TAP4NN 01BA

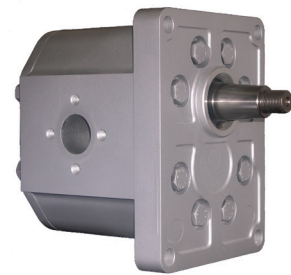



## Technical data for TAP4NN

TAP4NN pump model		Frame size						
		60	85	106	130	148	180	200
Displacement	cm <sup>3</sup> /rev [in <sup>3</sup> /rev]	58.0 [3.54]	83.3 [5.08]	103.4 [6.31]	126.1 [7.69]	143.8 [8.77]	174.1 [10.62]	194.3 [11.86]
Peak pressure	bar [psi]	230 [3335]	230 [3335]	230 [3335]	230 [3335]	220 [3190]	180 [2610]	160 [2320]
Rated pressure		220 [3190]	220 [3190]	220 [3190]	220 [3190]	210 [3045]	170 [2465]	150 [2175]
Minimum speed	min <sup>-1</sup> (rpm)	650	650	600	550	500	500	480
Maximum speed		3000	3000	2500	2500'	2400	2400	2400
Weight	kg [lb]	13.45 [29.65]	14.4 [31.75]	14.9 [32.85]	15.75 [34.72]	17.2 [37.92]	17.25 [38.03]	18 [39.68]
Moment of inertia of rotating components	x 10 <sup>-6</sup> kg·m <sup>2</sup> [x 10 <sup>-6</sup> lbf·ft <sup>2</sup> ]	682,7 16193,6	839 19901,1	965,2 22894,5	1106,5 26246,2	1216,4 28853,0	1216,4 28853,0	1530,3 36298,7
Theoretical flow at maximum speed	l/min [US gal/min]	174.0 [46.0]	249.9 [66.0]	258.5 [68.3]	315.2 [83.3]	345.1 [91.2]	417.8 [110.4]	466.3 [123.2]

### ! Caution

The rated and peak pressure mentioned are for pumps with flanged ports only. When threaded ports are required a de-rated performance has to be considered. To verify the compliance of an high pressure application with a threaded ports pump apply to a Turolla representative.



### Determination of nominal pump sizes

Use these formulae to determine the nominal pump size for a specific application:

#### Based on SI units

$$\text{Output flow: } Q = \frac{V_g \cdot n \cdot \eta_v}{1000} \quad \text{l/min}$$

$$\text{Input torque: } M = \frac{V_g \cdot \Delta p}{20 \cdot \pi \cdot \eta_m} \quad \text{N}\cdot\text{m}$$

$$\text{Input power: } P = \frac{M \cdot n}{9550} = \frac{Q \cdot \Delta p}{600 \cdot \eta_t} \quad \text{kW}$$

#### Based on US units

$$Q = \frac{V_g \cdot n \cdot \eta_v}{231} \quad \text{[US gal/min]}$$

$$M = \frac{V_g \cdot \Delta p}{2 \cdot \pi \cdot \eta_m} \quad \text{[lbf}\cdot\text{in]}$$

$$P = \frac{M \cdot n}{63.025} = \frac{Q \cdot \Delta p}{1714 \cdot \eta_t} \quad \text{[hp]}$$

*Variables:* SI units [US units]

$V_g$	= Displacement per rev.	cm <sup>3</sup> /rev [in <sup>3</sup> /rev]
$p_{HD}$	= Outlet pressure	bar [psi]
$p_{ND}$	= Inlet pressure	bar [psi]
$\Delta p$	= $p_{HD} - p_{ND}$	bar [psi]
$n$	= Speed	min <sup>-1</sup> (rpm)
$\eta_v$	= Volumetric efficiency	
$\eta_m$	= Mechanical (torque) efficiency	
$\eta_t$	= Overall efficiency ( $\eta_v \cdot \eta_m$ )	



## Product code

### Model code

A	B	C	D	E	F	G	H	I	J	K	L	M	N	O
<input type="text"/>	<input type="text"/>	<input type="text"/>	<input type="text"/>	<input type="text"/>	<input type="text"/>	<input type="text"/>	<input type="text"/>	<input type="text"/>	<input type="text"/>	<input type="text"/>	<input type="text"/>	<input type="text"/>	<input type="text"/>	<input type="text"/>

#### A Family

<b>TAP4NN</b>	Group 4 pumps from 60 up to 200 cc
---------------	------------------------------------

#### B Displacement

<b>060</b>	58 cc
<b>075</b>	75,6 cc - Special
<b>085</b>	83,3 cc
<b>106</b>	103,4 cc
<b>130</b>	126,1 cc
<b>148</b>	143,8 cc
<b>180</b>	174,1 cc
<b>200</b>	194,3 cc

#### C Rotation

<b>L</b>	Left hand rotation
<b>R</b>	Right hand rotation

#### D Project version

<b>N</b>	Std Version of Project
----------	------------------------





A	B	C	D	E	F	G	H	I	J	K	L	M	N	O
<input type="text"/>	<input type="text"/>	<input type="text"/>	<input type="text"/>	<input type="text"/>	<input type="text"/>	<input type="text"/>	<input type="text"/>	<input type="text"/>	<input type="text"/>	<input type="text"/>	<input type="text"/>	<input type="text"/>	<input type="text"/>	<input type="text"/>

## E Mounting flange

Code	Description (Type of flange • Type of drive gear • Preferred ports for configuration)
01	European 4 bolt - Pilot Ø63,5
02	SAE C 2 bolt - Pilot Ø127
F1	European 4 bolt - Pilot Ø63,5 (special FIAT-ALLIS)

## F Drive gear

BA	Taper 1:8-M20x1,5-Key 6,375
DA	Spline DIN 5482 B35x31xL44
FA	Parallel Ø30-Key 8x7xL50
GA	Parallel Ø31,75-Key 7,962x7x36
RA	Splined-SAE J498-14T-12/24-SAE C 2 bolt
HA	Splined-m2,75-z10-a30°-Special SC01 AAM
HB	Splined-m2,75-z10-a30°-Special SC01 AEZ
HC	Splined-m2,75-z10-a30°-Special SC01 AAH
HD	Splined-m2,75-z10-a30°-Special SC01 AAL
HE	Splined-m2,75-z10-a30°-Special SC01 AGA
HF	Splined-m2,75-z10-a30°-Special SC01 AAK
HH	Splined-m2,75-z10-a30°-Special SC01 AFS

## G Rear cover

P1	Standard cover pump
----	---------------------

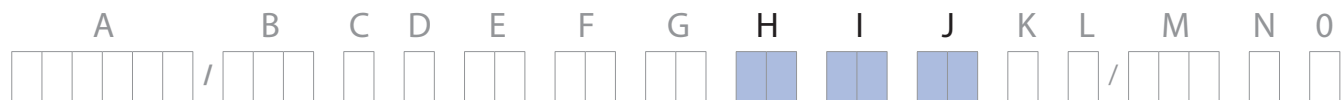

## H Inlet size    I Outlet size

<b>A4</b>	31x30,18x58,72x7/16-14UNC		<b>F7</b>	1-1/4 GAS	
<b>A5</b>	37,5x35,71x69,85x1/2-13UNC		<b>F8</b>	1-1/2 GAS	
<b>A6</b>	50x42,88x77,77x1/2-13UNC		<b>F9</b>	1-3/4 GAS	
<b>CB</b>	30x56xM10		<b>GE</b>	32x62x7/16-14UNC	
<b>CC</b>	32x62xM10		<b>GF</b>	38x72,5x1/2-13UNC	
<b>CD</b>	36x62xM10		<b>GK</b>	48x72,5x1/2-13UNC	
<b>CE</b>	32x62xM12				
<b>CF</b>	38x72,5xM12				
<b>CG</b>	40x72,5xM12				
<b>CH</b>	45x72,5xM12				
<b>CK</b>	48x72,5xM12				
<b>CL</b>	56x92xM12				

## J Ports positions & Special body

<b>NN</b>	Std position from catalogue
<b>SD</b>	Body width side ports=151mm (Std for 02 Falnge)
<b>G9</b>	Ports distance from flange=79 - Special
<b>I5</b>	Ports distance from flange =95 - Special
<b>L0</b>	Ports distance from flange =100 - Special
<b>LI</b>	Ports distance from flange =104,5 - Special



## **K** Seals

<b>N</b>	Standard NBR seals
----------	--------------------

## **L** Screws

<b>N</b>	Std burnished screws
----------	----------------------

## **M** Set valve

<b>NNN</b>	No valve
------------	----------

## **N** Type mark

<b>N</b>	Standard Turolla Marking
<b>A</b>	Standard Turolla Marking+Customer Code - Special
<b>Z</b>	Without Marking

## **O** Mark position

<b>N</b>	Std Marking position (on top)
<b>A</b>	Special Marking position on the bottom - Special



# System Requirements

## Pressure

The inlet vacuum must be controlled in order to realize expected pump life and performance. The system design must meet inlet pressure requirements during all modes of operation. Expect lower inlet pressures during cold start. It should improve quickly as the fluid warms.

**Peak pressure** is the highest intermittent pressure allowed. The relief valve overshoot (reaction time) determines peak pressure. It is assumed to occur for less than 100 ms. **The illustration to the right** shows peak pressure in relation to rated pressure and reaction time (100 ms maximum).

**Rated pressure** is the average, regularly occurring, operating pressure that should yield satisfactory product life. The maximum machine load demand determines rated pressure. For all systems, the load should move below this pressure.

**System pressure** is the differential of pressure between the outlet and inlet ports. It is a dominant operating variable affecting hydraulic unit life. High system pressure, resulting from high load, reduces expected life. System pressure must remain at, or below, rated pressure during normal operation to achieve expected life.

## Speed

**Maximum speed** is the limit recommended by Turolla for a particular gear pump when operating at rated pressure. It is the highest speed at which normal life can be expected.

The lower limit of operating speed is the **minimum speed**. It is the lowest speed at which normal life can be expected. The minimum speed increases as operating pressure increases. When operating under higher pressures, a higher minimum speed must be maintained, as illustrated to the right.

### Inlet pressure

<b>Max. continuous vacuum</b>		0.8 [23.6]
<b>Max. intermittent vacuum</b>	bar abs. [in. Hg]	0.6 [17.7]
<b>Max. pressure</b>		3.0 [88.5]

### Time versus pressure

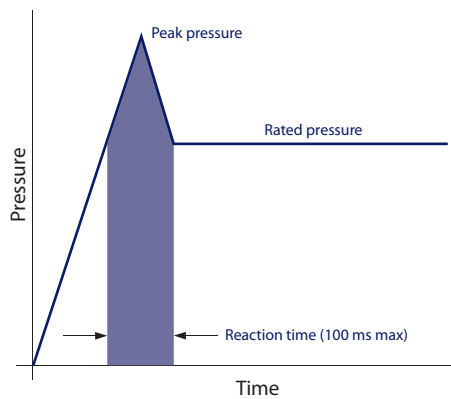

### Speed versus pressure

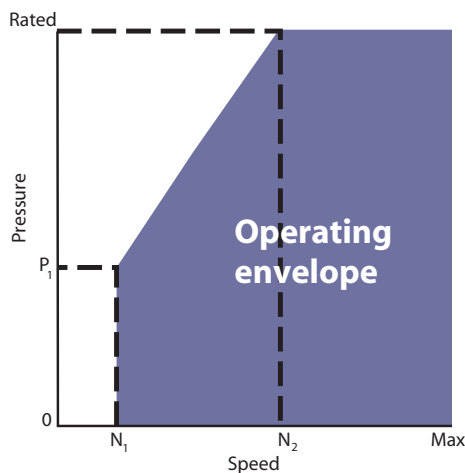

Where:  
 N<sub>1</sub> = Minimum speed at 100 bar  
 N<sub>2</sub> = Minimum speed at 180 bar



## Hydraulic fluids

Ratings and data for TAP4NN gear pumps are based on operating with premium hydraulic fluids containing oxidation, rust, and foam inhibitors. These fluids must possess good thermal and hydrolytic stability to prevent wear, erosion, and corrosion of internal components. They include:

- Hydraulic fluids following DIN 51524, part 2 (HLP) and part 3 (HVLP) specifications
- API CD engine oils conforming to SAE J183
- M2C33F or G automatic transmission fluids
- Certain agricultural tractor fluids

Use only clean fluid in the pump and hydraulic circuit.

### ! Caution

Never mix hydraulic fluids.

Please see Turolla publication [Hydraulic Fluids and Lubricants Technical Information, L1021414](#) for more information.

## Temperature and Viscosity

**Temperature and viscosity requirements** must be concurrently satisfied. Use petroleum / mineral-based fluids.

High temperature limits apply at the inlet port to the pump. The pump should run at or below the maximum continuous temperature. The peak temperature is based on material properties. Don't exceed it.

Cold oil, generally, doesn't affect the durability of pump components. It may affect the ability of oil to flow and transmit power. For this reason, keep the temperature at 16 °C [60 °F] above the pour point of the hydraulic fluid.

Minimum (cold start) temperature relates to the physical properties of component materials.

Minimum viscosity occurs only during brief occasions of maximum ambient temperature and severe duty cycle operation. You will encounter maximum viscosity only at cold start. During this condition, limit speeds until the system warms up. Size heat exchangers to keep the fluid within these limits. Test regularly to verify that these temperatures and viscosity limits aren't exceeded. For maximum unit efficiency and bearing life, keep the fluid viscosity in the recommended viscosity range.

### Fluid viscosity

<b>Maximum (cold start)</b>		1000 [4600]
<b>Recommended range</b>	mm <sup>2</sup> /s [SUS]	12-60 [66-290]
<b>Minimum</b>		10 [60]

### Temperature

<b>Minimum (cold start)</b>		-20 [-4]
<b>Maximum continuous</b>	°C [°F]	80 [176]
<b>Peak (intermittent)</b>		90 [194]



## Filtration

### Filters

Use a filter that conforms to Class 22/18/13 of ISO 4406 (or better). It may be on the pump outlet (pressure filtration), inlet (suction filtration), or reservoir return (return-line filtration).

### Selecting a filter

When selecting a filter, please consider:

- contaminant ingress rate (determined by factors such as the number of actuators used in the system)
- generation of contaminants in the system
- required fluid cleanliness
- desired maintenance interval
- filtration requirements of other system components

Measure filter efficiency with a Beta ratio ( $\beta_x$ ). For:

- suction filtration, with controlled reservoir ingress, use a  $\beta_{35-45} = 75$  filter
- return or pressure filtration, use a pressure filtration with an efficiency of  $\beta_{10} = 75$ .

$\beta_x$  ratio is a measure of filter efficiency defined by ISO 4572. It is the ratio of the number of particles greater than a given diameter (" $x$ " in microns) upstream of the filter to the number of these particles downstream of the filter.

### Fluid cleanliness level and $\beta_x$ ratio

<b>Fluid cleanliness level (per ISO 4406)</b>	Class 22/18/13 or better
<b><math>\beta_x</math> ratio (suction filtration)</b>	$\beta_{35-45} = 75$ and $\beta_{10} = 2$
<b><math>\beta_x</math> ratio (pressure or return filtration)</b>	$\beta_{10} = 75$
<b>Recommended inlet screen size</b>	100-125 $\mu\text{m}$ [0.004-0.005 in]

The filtration requirements for each system are unique. Evaluate filtration system capacity by monitoring and testing prototypes.



## Reservoir

The **reservoir** provides clean fluid, dissipates heat, removes entrained air, and allows for fluid volume changes associated with fluid expansion and cylinder differential volumes. A correctly sized reservoir accommodates maximum volume changes during all system operating modes. It promotes deaeration of the fluid as it passes through, and accommodates a fluid dwell-time between 60 and 180 seconds, allowing entrained air to escape.

**Minimum reservoir capacity** depends on the volume required to cool and hold the oil from all retracted cylinders, allowing for expansion due to temperature changes. A fluid volume of 1 to 3 times the pump output flow (per minute) is satisfactory. The minimum reservoir capacity is 125% of the fluid volume.

Install the suction line above the bottom of the reservoir to take advantage of gravity separation and prevent large foreign particles from entering the line. Cover the line with a 100-125 micron screen. The pump should be below the lowest expected fluid level.

Put the return-line below the lowest expected fluid level to allow discharge into the reservoir for maximum dwell and efficient deaeration. A baffle (or baffles) between the return and suction lines promotes deaeration and reduces fluid surges.

## Line sizing

Choose pipe sizes that accommodate minimum fluid velocity to reduce system noise, pressure drops, and overheating. This maximizes system life and performance. Design inlet piping that maintains continuous pump inlet pressure above 0.8 bar absolute during normal operation. The line velocity should not exceed the values in this table:

Maximum line velocity

<b>Inlet</b>		2.5 [8.2]
<b>Outlet</b>	m/s [ft/sec]	5.0 [16.4]
<b>Return</b>		3.0 [9.8]

Most systems use hydraulic oil containing 10% dissolved air by volume. Under high inlet vacuum conditions the oil releases bubbles. They collapse when subjected to pressure, resulting in cavitation, causing adjacent metal surfaces to erode. **Over-aeration** is the result of air leaks on the inlet side of the pump, and flow-line restrictions. These include inadequate pipe sizes, sharp bends, or elbow fittings, causing a reduction of flow line cross sectional area. This problem will not occur if inlet vacuum and rated speed requirements are maintained, and reservoir size and location are adequate.



## Pump drive

Shaft options for Group 4 gear pumps include tapered, splined, or parallel shafts. They are suitable for a wide range of direct and indirect drive applications for radial and thrust loads.

**Plug-in drives**, acceptable only with a splined shaft, can impose severe radial loads when the mating spline is rigidly supported. Increasing spline clearance does not alleviate this condition.

Use plug-in drives if the concentricity between the mating spline and pilot diameter is within 0.1 mm [0.004 in]. Lubricate the drive by flooding it with oil. A 3-piece coupling minimizes radial or thrust shaft loads.

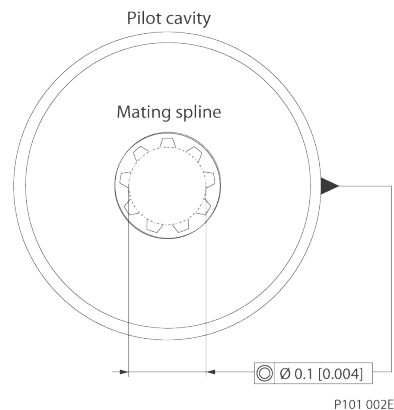

### ⚠ Caution

In order to avoid spline shaft damages it is recommended to use carburised and hardened steel couplings with 80-82 HRA surface hardness.

Allowable **radial shaft loads** are a function of the load position, load orientation, and operating pressure of the hydraulic pump. All external shaft loads have an effect on bearing life, and may affect pump performance.

In applications where external shaft loads can't be avoided, minimize the impact on the pump by optimizing the orientation and magnitude of the load. Don't use splined shafts for belt or gear drive applications. A spring-loaded belt tension-device is recommended for belt drive applications to avoid excessive tension. Avoid thrust loads in either direction.





### Pump drive data form

Contact Turolla if continuously applied external radial or thrust loads occur.

Fill out this page and send the complete form to your Turolla representative for an assistance in applying pumps with belt or gear drive. This illustration shows a pump with counterclockwise orientation:

#### Optimal radial load position

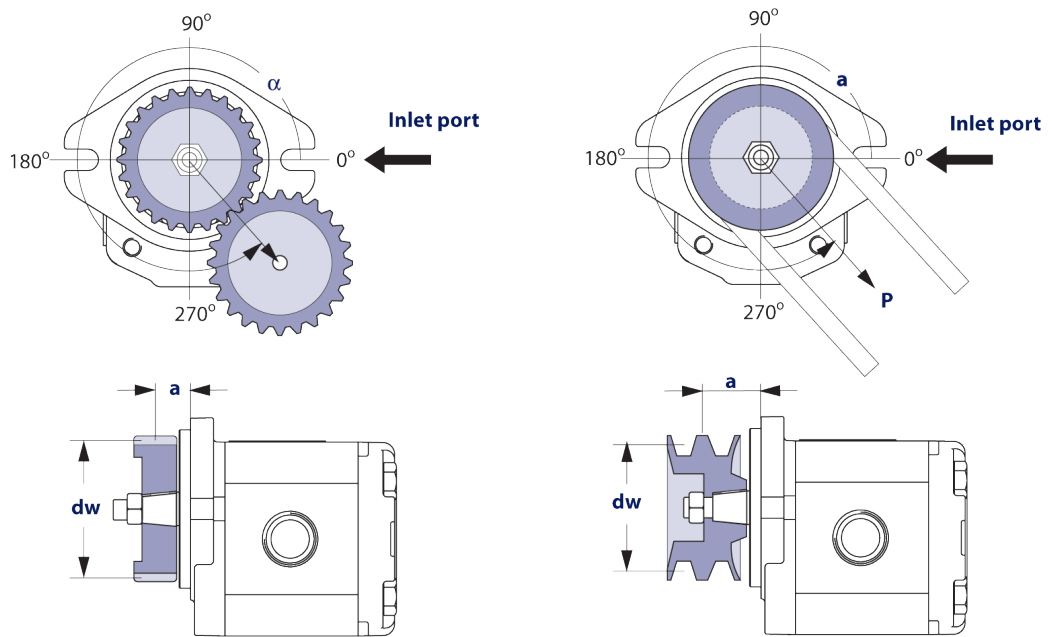

#### Application data

Item	Value	Unit
Pump displacement		cm <sup>3</sup> /rev [in <sup>3</sup> /rev]
Rated system pressure		<input type="checkbox"/> bar <input type="checkbox"/> psi
Relief valve setting		
Pump shaft rotation		<input type="checkbox"/> left <input type="checkbox"/> right
Pump minimum speed		min <sup>-1</sup> (rpm)
Pump maximum speed		
Drive gear helix angle (gear drive only)		degree
Belt type (gear drive only)		<input type="checkbox"/> V <input type="checkbox"/> notch
Belt tension (gear drive only)	<b>P</b>	<input type="checkbox"/> N <input type="checkbox"/> lbf
Angular orientation of gear or belt to inlet port	<b>α</b>	degree
Pitch diameter of gear or pulley	<b>d<sub>w</sub></b>	<input type="checkbox"/> mm <input type="checkbox"/> in
Distance from flange to center of gear or pulley	<b>a</b>	



## Pump life

**Pump life** is a function of speed, system pressure, and other system parameters (such as fluid quality and cleanliness).

All Turolla gear pumps use hydrodynamic journal bearings that have an oil film maintained between the gear / shaft and bearing surfaces at all times. If the oil film is sufficiently sustained through proper system maintenance and operating within recommended limits, long life can be expected.

---

**B10 life expectancy number is generally associated with rolling element bearings. It does not exist for hydrodynamic bearings.**

---

High pressure, resulting from high loads, impacts pump life. When submitting an application for review, provide machine duty cycle data that includes percentages of time at various loads and speeds. We strongly recommend a prototype testing program to verify operating parameters and their impact on life expectancy before finalizing any system design.



## Product Options

### Shaft, flange, and port configurations

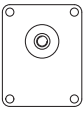
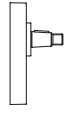
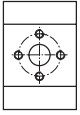
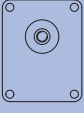
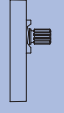
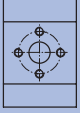
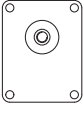
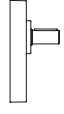
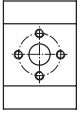
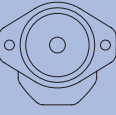
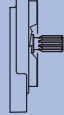
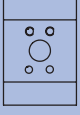
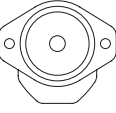
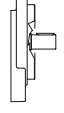
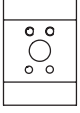
Pump	Code	Flange	Shaft	Port
TAP4NN	01BA	pilot Ø 63.5 mm [2.5 in] European 01, 4-bolt 	1:8 tapered 	European flanged port + pattern 
TAP4NN	01DA	pilot Ø 63.5 mm [2.5 in] European 01, 4-bolt 	Spline DIN 5482 B35x31xL44 	European flanged port + pattern 
TAP4NN	01FA	pilot Ø 63.5 mm [2.5 in] European 01, 4-bolt 	Parallel Ø30-Key 8x7xL50 	European flanged port + pattern 
TAP4NN	02RA	pilot Ø 127 mm [5.0 in] SAE C, 2-bolt 	Splined-SAE J498-14T 	Vertical four bolt flanged port 
TAP4NN	02GA	pilot Ø 127 mm [5.0 in] SAE C, 2-bolt 	Parallel Ø31,75-Key 7,962x7x36 	Vertical four bolt flanged port 



## Mounting flanges

Turolla offers many types of industry standard mounting flanges. This table shows order codes for each available mounting flange and its intended use:

Flange availability



Code	Description
<b>01</b>	European 4 bolt - Pilot Ø63,5
<b>02</b>	SAE C 2 bolt - Pilot Ø127
<b>F1</b>	European 4 bolt - Pilot Ø63,5 (special FIAT-ALLIS)



### Shaft options

Direction is viewed facing the shaft. Group 4 pumps are available with a variety of splined, parallel, and tapered shaft ends. Not all shaft styles are available with all flange styles.

Shaft availability and nominal torque capability

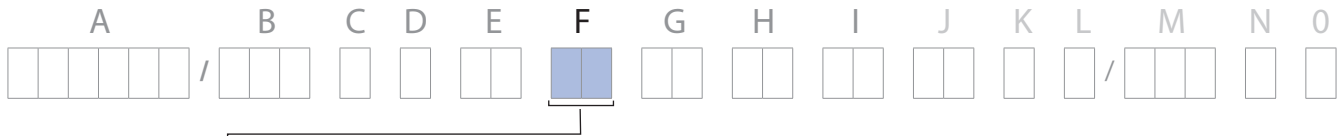

Shaft		Mounting flange code with maximum torque in Nm [lb·in]	
		01	02
<b>BA</b>	Taper 1:8-M20x1,5-Key 6,375	970 [8585]	
<b>DA</b>	Spline DIN 5482 B35x31xL44	850 [7523]	
<b>FA</b>	Parallel Ø30-Key 8x7xL50	710 [6284]	
<b>GA</b>	Parallel Ø31,75-Key 7,962x7x36		750 [6638]
<b>RA</b>	Splined-SAE J498-14T-12/24-SAE C 2 bolt		800 [7080]

Turolla recommends mating splines conform to SAE J498 or DIN 5482. Turolla external SAE splines have a flat root side fit with circular tooth thickness reduced by 0.127 mm [0.005 in] in respect to class 1 fit. Dimensions are modified to assure a clearance fit with the mating spline.

### ⚠ Caution

Shaft torque capability may limit allowable pressure. Torque ratings assume no external radial loading. Applied torque must not exceed these limits, regardless of stated pressure parameters. Maximum torque ratings are based on shaft torsional fatigue strength.



### Port configurations

Various port configurations are available on Group 4 pumps. They include:

- SAE split flange ports
- European standard flanged ports
- GAS threaded ports (BSPP)

A table of dimensions is on the next page.

Available port configurations

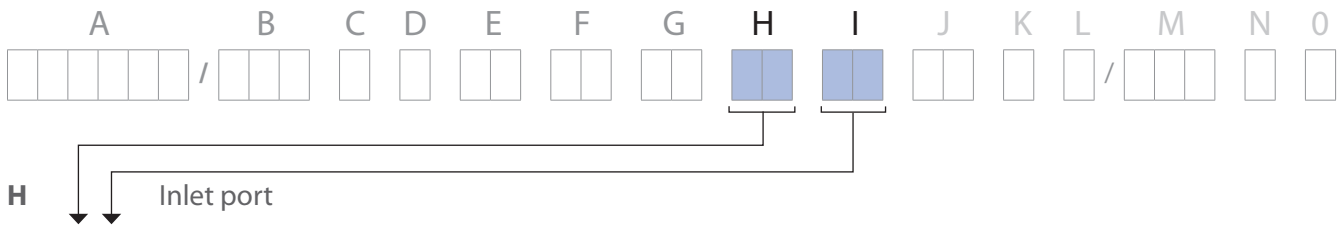

Code	Description	
<b>A4</b>	31x30,18x58,72x7/16-14UNC	SAE flanged port
<b>A5</b>	37,5x35,71x69,85x1/2-13UNC	
<b>A6</b>	50x42,88x77,77x1/2-13UNC	
<b>CB</b>	30x56xM10	Flanged port with thd holes in + pattern
<b>CC</b>	32x62xM10	
<b>CD</b>	36x62xM10	
<b>CE</b>	32x62xM12	
<b>CF</b>	38x72,5xM12	
<b>CG</b>	40x72,5xM12	
<b>CH</b>	45x72,5xM12	
<b>CK</b>	48x72,5xM12	
<b>CL</b>	56x92xM12	Threaded GAS (BSPP)
<b>F7</b>	1-1/4 GAS	
<b>F8</b>	1-1/2 GAS	
<b>F9</b>	1-3/4 GAS	Flanged port with thd holes in + pattern UN thread
<b>GE</b>	32x62x7/16-14UNC	
<b>GF</b>	38x72,5x1/2-13UNC	
<b>GK</b>	48x72,5x1/2-13UNC	

### I Outlet port

For code letters and descriptions see [the table above](#).



### Porting

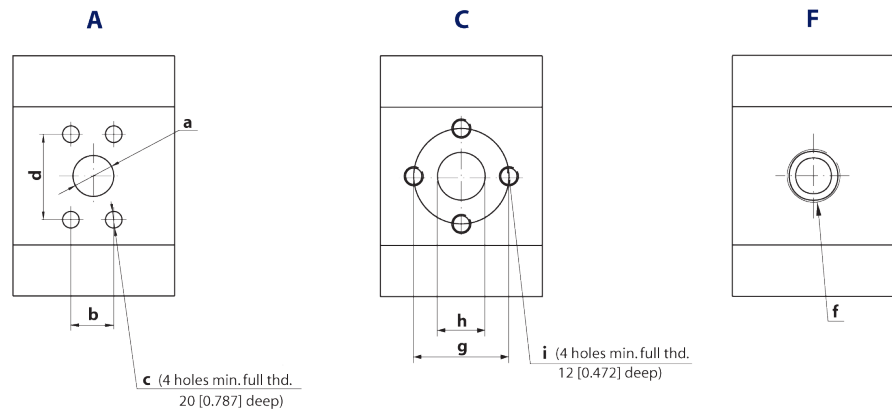

### Ports dimensions

Port type		A				C			E	
Dimensions		a	b	d	c	g	h	i	f	
Type (displacement)	060	Inlet	38.1 [1.5]	35.71 [1.4]	69.85 [2.75]	1/2 -13 UNC	62 [2.44]	36 [1.42]	M10	1-1/2 Gas (BSPP)
		Outlet	31.8 [1.25]	30.18 [1.19]	58.72 [2.31]	7/16 - 14UNC	56 [2.2]	30 [1.18]	M10	1-1/4 Gas (BSPP)
	080	Inlet	38.1 [1.5]	35.71 [1.4]	69.85 [2.75]	1/2 -13 UNC	62 [2.44]	36 [1.42]	M10	1-1/2 Gas (BSPP)
		Outlet	31.8 [1.25]	30.18 [1.19]	58.72 [2.31]	7/16 - 14UNC	56 [2.2]	30 [1.18]	M10	1-1/4 Gas (BSPP)
	106	Inlet	50.8 [2.0]	42.88 [1.69]	77.77 [3.06]	1/2 -13 UNC	62 [2.44]	36 [1.42]	M10	1-1/2 Gas (BSPP)
		Outlet	38.1 [1.5]	35.71 [1.4]	69.85 [2.75]	1/2 -13 UNC	56 [2.2]	30 [1.18]	M10	1-1/4 Gas (BSPP)
	130	Inlet	50.8 [2.0]	42.88 [1.69]	77.77 [3.06]	1/2 -13 UNC	72.5 [2.85]	45 [1.77]	M12	1-3/4 Gas (BSPP)
		Outlet	38.1 [1.5]	35.71 [1.4]	69.85 [2.75]	1/2 -13 UNC	62 [2.44]	36 [1.42]	M10	1-1/2 Gas (BSPP)
	148	Inlet	50.8 [2.0]	42.88 [1.69]	77.77 [3.06]	1/2 -13 UNC	72.5 [2.85]	45 [1.77]	M12	1-3/4 Gas (BSPP)
		Outlet	38.1 [1.5]	35.71 [1.4]	69.85 [2.75]	1/2 -13 UNC	62 [2.44]	36 [1.42]	M10	1-1/2 Gas (BSPP)
	180	Inlet	50.8 [2.0]	42.88 [1.69]	77.77 [3.06]	1/2 -13 UNC	92 [3.62]	56 [2.2]	M12	N/A
		Outlet	38.1 [1.5]	35.71 [1.4]	69.85 [2.75]	1/2 -13 UNC	72.5 [2.85]	45 [1.77]	M12	N/A
	200	Inlet	50.8 [2.0]	42.88 [1.69]	77.77 [3.06]	1/2 -13 UNC	92 [3.62]	56 [2.2]	M12	N/A
		Outlet	38.1 [1.5]	35.71 [1.4]	69.85 [2.75]	1/2 -13 UNC	72.5 [2.85]	45 [1.77]	M12	N/A



# Dimensions

## TAP4NN – 01FA, 01DA and 01BA

The drawing shows the TAP4NN standard porting for 01FA, 01DA and 01BA.

mm  
[in]

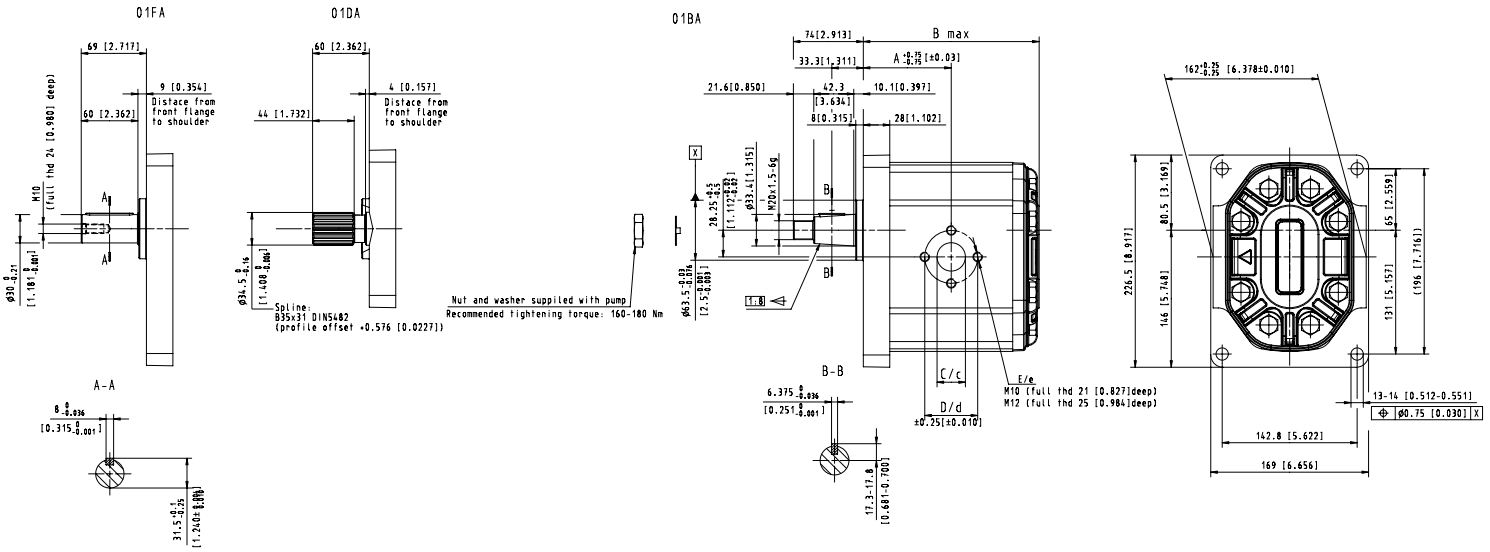

### TAP4NN – 01FA, 01DA, 01BA dimensions

Frame size		060	085	106	130	148	180	200
Dimension	A	84 [3.3]	89 [3.5]	93 [3.66]	97.5 [3.84]	101 [3.98]	107 [4.21]	111 [4.37]
	B	168 [6.61]	178 [7.0]	186 [7.32]	195 [7.68]	202 [7.95]	214 [8.42]	222 [8.74]
Inlet	C	36 [1.42]			45 [1.77]		56 [2.2]	
	D	62 [2.44]			72.5 [2.85]		92 [3.62]	
	E	M10			M12		M12	
Outlet	c	30 [1.18]			36 [1.42]		45 [1.77]	
	d	56 [2.2]			62 [2.44]		72.5 [2.85]	
	e	M10			M10		M12	

### Model code examples and maximum shaft torque

Flange/drive gear	Model code example	Maximum shaft torque
01DA	TAP4NN/106LN01DAP1CDCBNNNN/NNNNN	850 [7523]
01FA	TAP4NN/148RN01FAP1CHCDNNNN/NNNNN	710 [6284]
01BA	TAP4NN/180RN01BAP1CLCH NNNN/NNNNN	970 [8585]

For further details on ordering, see [Model Code](#), pages 8 - 11.





### TAP4NN – 02RA and 02GA

This drawing shows the standard porting for 02RA and 02GA.

mm  
[in]

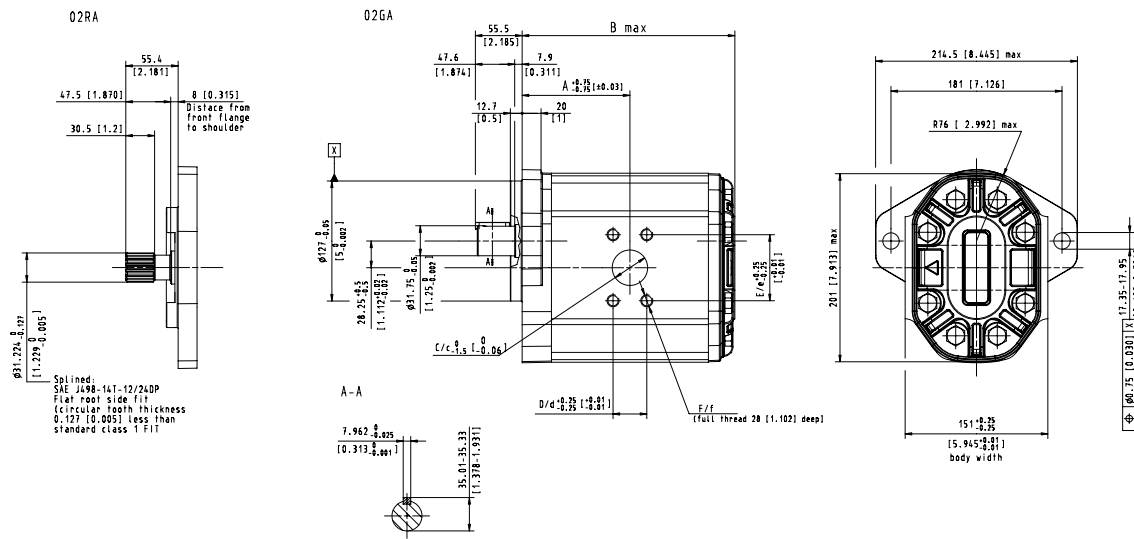

### TAP4NN – 02RA, 02GA dimensions

Frame size		060	085	106	130	148	180	200
Dimension	A	87 [3.42]	92 [3.62]	96 [3.78]	100.5 [3.96]	104 [4.1]	110 [4.33]	114 [4.49]
	B	171 [6.73]	181 [7.13]	189 [7.44]	198 [7.79]	205 [8.07]	217 [8.54]	225 [8.86]
Inlet	C	38.1 [1.5]			50.8 [2.0]			
	D	35.71 [1.4]			42.88 [1.69]			
	E	69.85 [2.75]			77.77 [3.06]			
	F	1/2-13UNC			1/2-13UNC			
Outlet	c	31.8 [1.25]			38.1 [1.5]			
	d	30.18 [1.19]			35.71 [1.4]			
	e	58.72 [2.31]			69.85 [2.75]			
	f	7/16-14UNC			1/2-13UNC			

### Model code examples and maximum shaft torque

Flange/drive gear configuration	Model code example	Maximum shaft torque N·m [lb·in]
02RA	TAP4NN/060RN02RAP1A5A4SDNN/NNNNN	800 [7080]
02GA	TAP4NN/130LN02GAP1A6A5SDNN/NNNNN	750 [6638]

For further details on ordering, see [Model Code](#), pages 8 - 11.



# Notes



# Notes

**Italy**

Via Villanova 28  
40055 Villanova di Castenaso  
Bologna, Italia  
Telephone: +39 051 6054 411

**U.S.A.**

2800 East 13th Street  
Ames, IA 50010, USA  
Phone: +1 515 239 6677  
Fax: +1 515 239 6618

**Slovakia**

Kukučínova 2148-84  
01701 Považská Bystrica, Slovakia  
Phone: +421 424 301 202  
Fax: +421 424 301 626

E-mail: [turollaocg@turollaocg.com](mailto:turollaocg@turollaocg.com)  
[www.turollaocg.com](http://www.turollaocg.com)

Local address

